



# Delta PQC Series Power Quality Solution

Active Power Filter (APF)

Static VAR Generator (SVG)

# About Delta Group

## Leading expert in power management and thermal management solutions

Delta, founded in 1971, is a global leader in switching power supplies and thermal management products with a thriving portfolio of smart energy-saving systems and solutions in the fields of industrial automation, building automation, telecom power, data center infrastructure, EV charging, renewable energy, energy storage and display, to nurture the development of smart manufacturing and sustainable cities. As a world-class corporate citizen guided by its mission statement, “To provide innovative, clean and energy-efficient solutions for a better tomorrow,” Delta leverages its core competence in high-efficiency power electronics and its CSR-embedded business model to address key environmental issues, such as climate change. Delta serves customers through its sales offices, R&D centers and manufacturing facilities spread over close to 200 locations across 5 continents.

## Delta's Manufacturing

The Delta Group's operations are global in scale with 48 manufacturing facilities in Taiwan, China, Thailand, India, Mexico, Brazil and Slovakia. We also have 72 R&D centers across the globe and 158 sales offices on all 5 continents.



# Delta's Green Business

Delta was nominated as one of the “Global Top 100 Low-Carbon Emission Enterprises” by the CNBC European Business Magazine.

Delta has won the “Corporate Social Responsibility Award and Honorary Award” from Global Views Magazine for four consecutive years.

Delta has won the “Corporate Citizenship Award” from Common Wealth Magazine for three consecutive years.

Delta Group’s mission statement, “To provide innovative, clean and energy-efficient solutions for a better tomorrow”, focuses on social responsibility and represents Delta’s confidence in putting advanced technology into practice on behalf of sustainability.

Delta Group’s president has said, “If Delta’s power efficiency is improved by just 1%, there can be fewer power plants in the world.”

# Delta's Technology

## Global Top 500 in Research and Development

Investing 5% of its annual operating revenues in R&D, Delta Group ranked No. 431 in a world ranking by the Department of Trade and Industry, United Kingdom.

The IEEE selects the three best theses every year to honor outstanding contributions to the academic fields of electrical and electronics engineering.

In September 2009, Delta’s thesis “Performance Evaluation of Bridgeless PFC Boost Rectifiers” stood out from 313 other theses and won the best thesis award issued by Prof. Deepak Divan, the IEEE Chairman, who presented the best thesis award to Milan M. Jovanovi, the manager of Delta’s R&D center in USA.



# Power Quality and Harmonics

## Power Quality Issues Overview

Power quality determines the suitability of electric power for consumer devices. There are three main contributors to low voltage and poor power quality problems:

- Harmonic Pollution causes extra stress on a power supply system and reduces reliability.
- Reactive Power loads the power supply system unnecessarily.
- Load Imbalance increases neutral current and neutral to earth voltage.

## Harmonics

Normally, power system generators produce a clean sinusoidal voltage waveform at their terminals. However, a lot of modern electronic equipment such as VFDs, UPSs, LEDs, battery chargers, and other equipment powered by switched-mode power supply (SMPS) equipment, generates non-sinusoidal current injected into the power system, which causes electrical harmonic pollution.

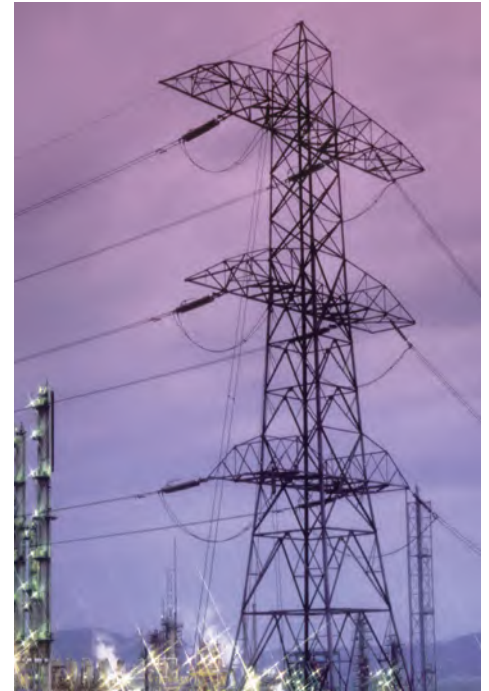

## Harmonics Standard

Based on "IEEE Recommended Practice and Requirements for Harmonic Control in Electrical Power Systems" (IEEE std 519-2014) , the grid voltage distortion limits:

Bus Voltage V at PCC	Individual harmonics	Total harmonics distortion THD
$V \leq 1.0$ kV	5.0%	8.0%
$1\text{kV} < V \leq 69$ kV	3.0%	5.0%
$69\text{kV} < V \leq 161$ kV	1.5%	2.5%
$161$ kV < V	1.0%	1.5%

### Current Distortion Limits for Systems Rated 120V through 69kV

Maximum Harmonic Current Distortion in Percent of $I_L$						
Individual Harmonic Order (Odd Harmonics)						
$I_{sc}/I_L$	$3 \leq h < 11$	$11 \leq h < 17$	$17 \leq h < 23$	$23 \leq h < 35$	$35 \leq h < 50$	TDD
$< 20^*$	4.0	2.0	1.5	0.6	0.3	5.0
$20 < 50$	7.0	3.5	2.5	1.0	0.5	8.0
$50 < 100$	10.0	4.5	4.0	1.5	0.7	12.0
$100 < 1000$	12.0	5.5	5.0	2.0	1.0	15.0
$> 1000$	15.0	7.0	6.0	2.5	1.4	20.0

Even harmonics are limited to 25% of the odd harmonic limits above.

Current distortion that results in a DC offset, such as half-wave converters, are not allowed.

\* All power generation equipment is limited to these values of current distortion, regardless of actual  $I_{sc}/I_L$ .

where

$I_{sc}$  = maximum short-circuit current at PCC.

$I_L$  = maximum demand load current (fundamental frequency component) at the PCC under normal load operating conditions.

## Reactive Power

In most cases, reactive power is the power that magnetic equipment such as transformers, motors and relays, needs to produce magnetizing flux, which is inductive. In some cases, long distance power cables and some loads generate capacitive reactive power. Both inductive and capacitive reactive power will increase the apparent power (kVA), demanding larger transformers and cable size.

## Load Imbalance

Every three-phase current can be divided into positive, negative and zero sequences. Negative and zero sequences cause load imbalance.

# Power Quality Problems

Poor Power Quality can be described as any event related to the electrical network that ultimately results in a financial loss. Possible consequences of poor Power Quality include:

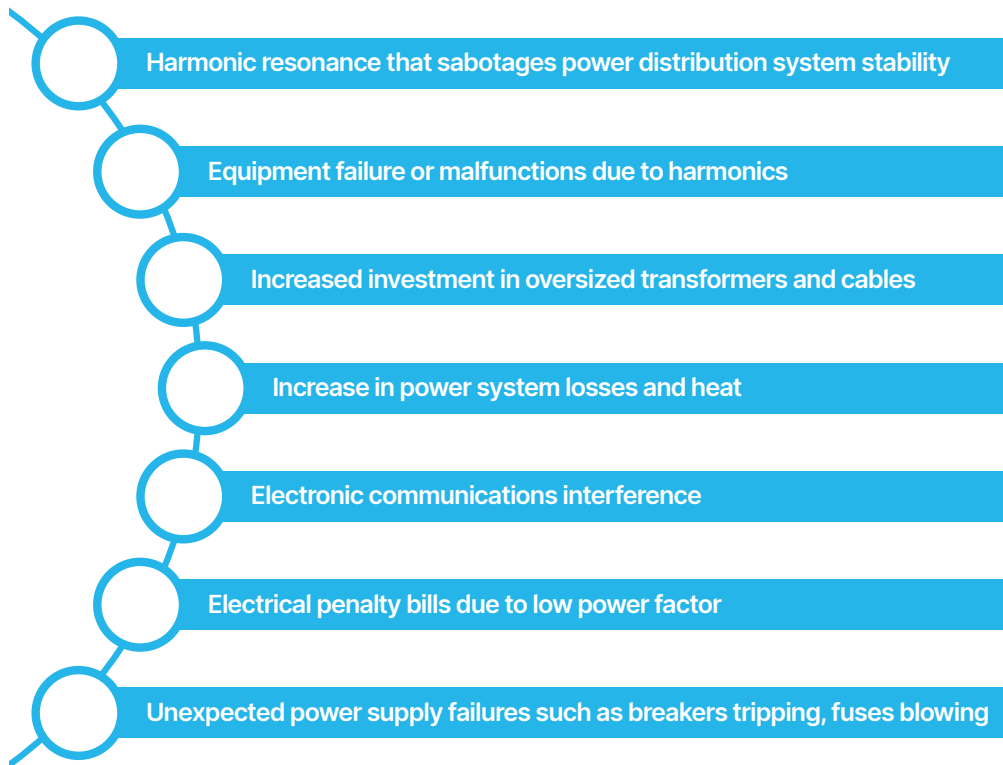

# Delta Power Quality Solution Evolution

Delta PQC series power quality solution consists of the Active Power Filter (APF) and Static VAR Generator (SVG). Both provide an active compensation solution based on power electronics technology.

Compared with conventional passive compensation solutions such as capacitor banks, an active compensation solution improves the reliability and quality of the power distribution system.

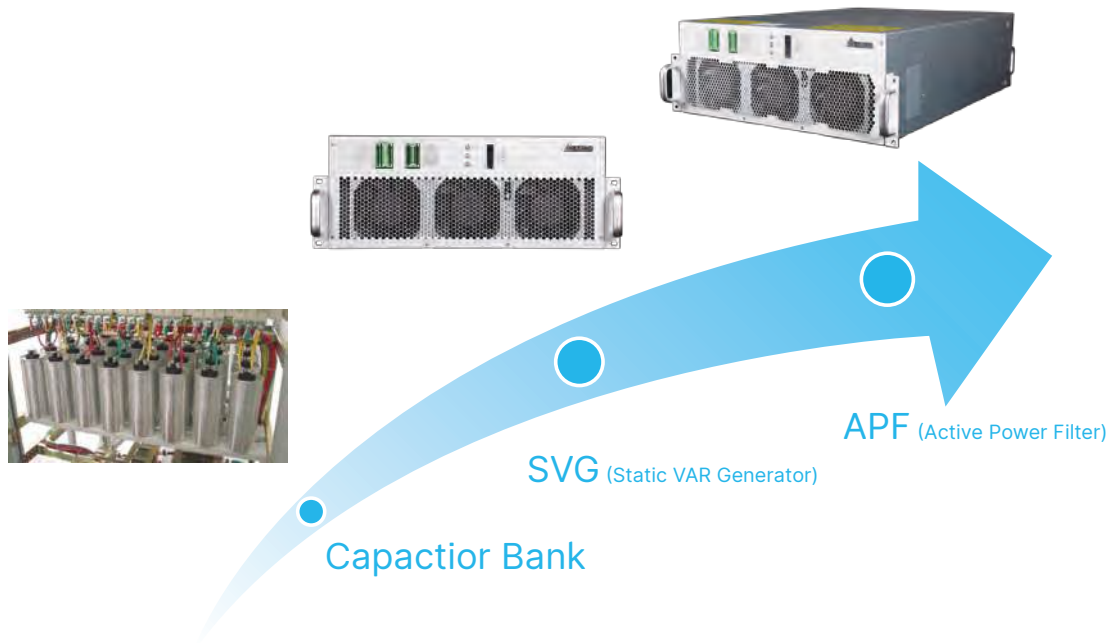

**Comparison between Capacitor Bank, SVG and APF**

Item	Capacitor Bank	SVG	APF
Harmonic Filtering	Unavailable	Eliminate 2 <sup>nd</sup> ~25 <sup>th</sup> harmonics (selectable) with limited capacity	Eliminate 2 <sup>nd</sup> ~50 <sup>th</sup> harmonics (selectable)
Reactive Power Compensation	Discretely compensate inductive reactive power only	Steplessly compensate both inductive and capacitive reactive power	Steplessly compensate both inductive and capacitive reactive power
Imbalance Correction	Unavailable	Available	Available
Response Speed	slow, can't track dynamic reactive power (20 ms~5 s)	fast, can track dynamic reactive power (< 0.1 ms)	fast, can track dynamic harmonic & reactive loads (< 0.1 ms)
Harmonic Resonance Problem	Potential resonance between capacitor and transformer sabotages power system stability.	Active compensation technology avoids harmonic resonance from the principle.	Active compensation technology avoids harmonic resonance from the principle.
Output Ability	Actual output capacity is less than the rated capacity.	Actual output capacity is the same as rated capacity.	Actual output capacity is the same as rated capacity.

# Delta PQC Series Active Power Filter (APF)

## APF Principle

Delta's PQC Series APF is connected in parallel with non-linear loads, and uses one set of current transformers (CT) to detect the load current. It calculates each order harmonic current by FFT algorithms in its DSP microchips, and then generates a compensating current with the same amplitude but opposite phase angles to the detected harmonic current, which cancels out the original load harmonics.

The PQC series APF not only eliminates harmonic current from the load side, but it also mitigates harmonic voltage caused by harmonic currents. The APF system can also improve power factor (PF) and correct load imbalances in the power system.

Note: CT is a critical part of the APF system, and it can be purchased by users themselves, following Delta's suggestions on CT specification.

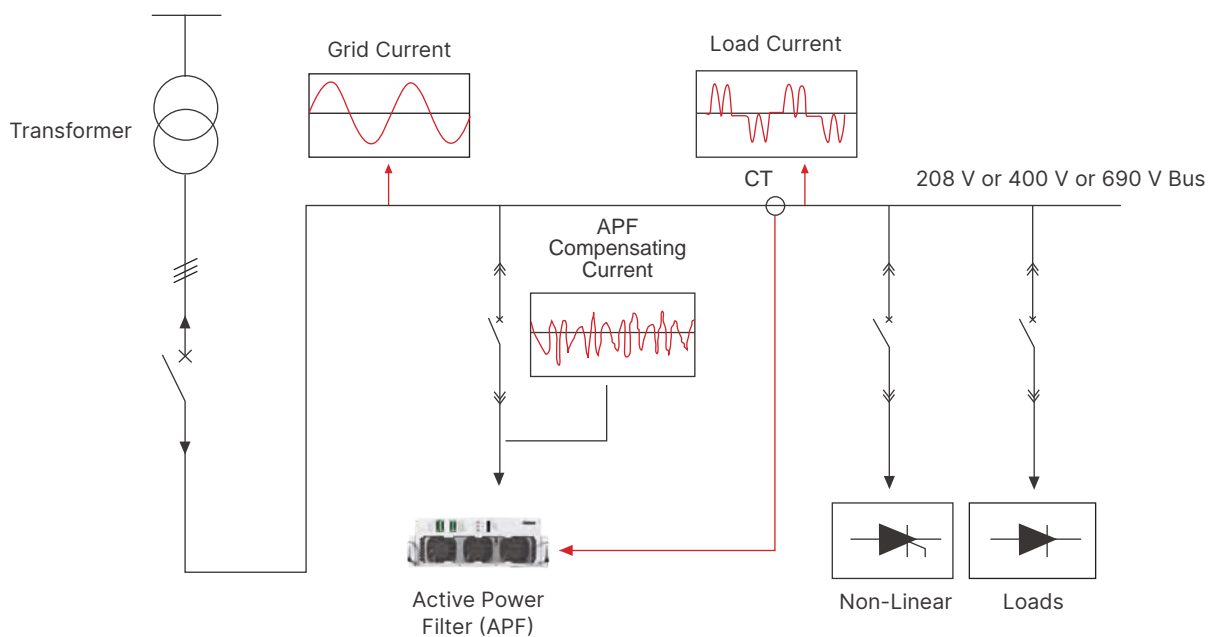

## APF Structure

Delta PQC Series APF has a modular design, which adopted 3-level inverter topology with 3 pcs modular IGBT and DC capacitor components, and the Delta Active Power Filter system consists of one or several APF modules and a 7" or 10" HMI display.

Each APF module is an independent harmonic filtering system, and users can change the harmonic filtering system rating by adding or removing APF modules.

According to the mounting type, Delta PQC series APF can be divided into Modular APF (rack mounting) and wall-mounted APF.

## APF Module and Cabinet Solutions

According to cable terminal type, a modular APF can be divided into two types:

- Drawer type modular APF (adding pluggable accessories on power cable terminals)
- Mixed fixed type modular APF(Power cables are fixed from rear side, Signal cables are fixed from front side.)

HMI has two types:

- 7" HMI
- 10" HMI

APF modules and HMI panel can be embedded in Delta's standard APF cabinet or a customized cabinet. There are breakers, cable terminals and Surge Protection Device (SPD) in the APF cabinet. Delta can supply IP30, IP42, IP54 or customized solutions.



APF cabinet



Mixed fixed APF module



7" HMI

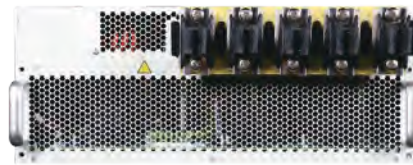

Drawer type APF module



10" HMI

## Wall-mounted APF Solutions

Delta's Wall-mounted APF can be installed on a wall, which is suitable for low rating applications, and wall-mounted type HMI can be installed on the wall-mounted APF module, along with a mounting bracket to provide support and protection. Delta can supply IP30, IP42, IP54 or customized solutions.



Combined wall-mounted IP30 APF system



Integral wall-mounted IP30 APF system



Wall-mounted IP54 APF system



## APF Compensation Performance

Delta's PQC Series APF can perfectly mitigate harmonic current, and suppress harmonic voltage caused by the harmonic current. When the APF capacity is sufficient and background harmonic voltage is low, the APF ensures excellent compensation performance at full load condition, as below.

- THDu (Total Harmonic Distortion of Voltage) < 3%
- THDi (Total Harmonic Distortion of Current) < 5%
- PF (Power Factor)  $\geq 0.99$  (improves both leading and lagging PF)
- Neutral Current Attenuation Ratio  $(\frac{I_{N(Before)} - I_{N(After)}}{I_{N(Before)}}) > 95\%$

## Delta's PQC Series APF Actual Compensation Performance



**Application:** Textile Industry

**Non-linear Loads:** Variable Frequency Drive (VFD).

**Compensation Result:** Current harmonic distortion (THDi) was reduced from 32.5% to 2.9%.

Current waveform and spectrum are recorded by Fluke 435, as below.

Current Waveform

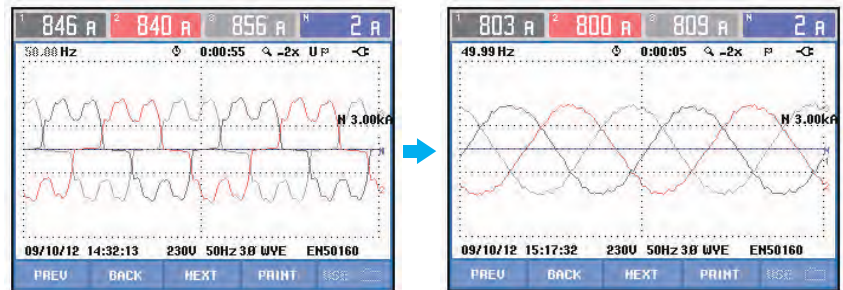

BEFORE

AFTER

Current Spectrum

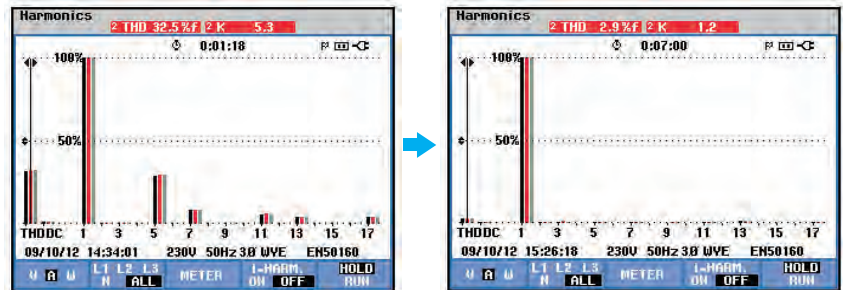

BEFORE

AFTER



**Application:** Foundry Industry

**Non-linear Loads:** Electric Welder

**Compensation Result:** Current harmonic distortion (THDi) was reduced from 70% to 4.4%, load imbalance was reduced from 102% to 6.1%.

Current waveform and spectrum are recorded by Fluke 435, as below.

**Current Waveform**

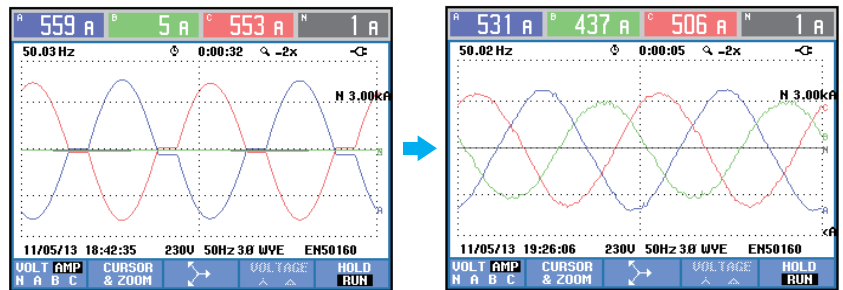

BEFORE

AFTER

**Current Spectrum**

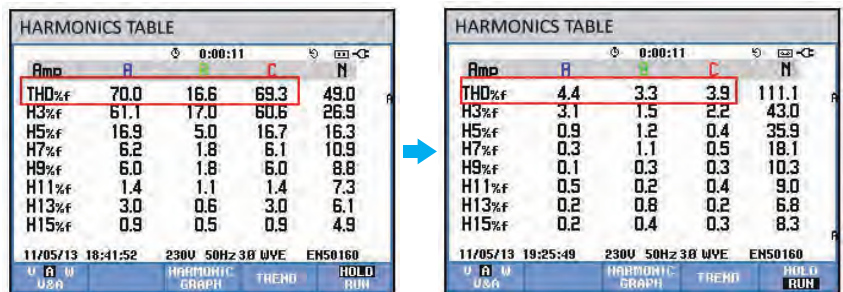

BEFORE

AFTER

**Load Unbalance**

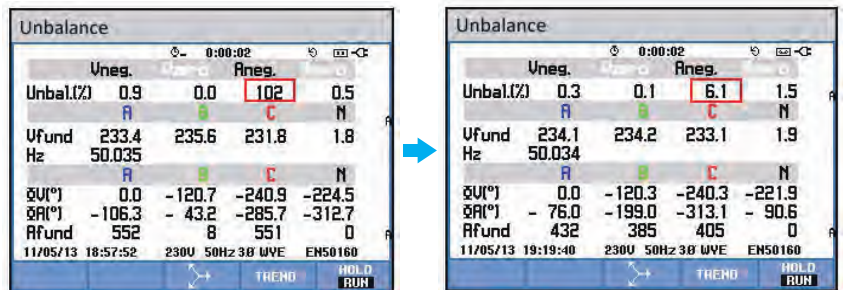

BEFORE

AFTER

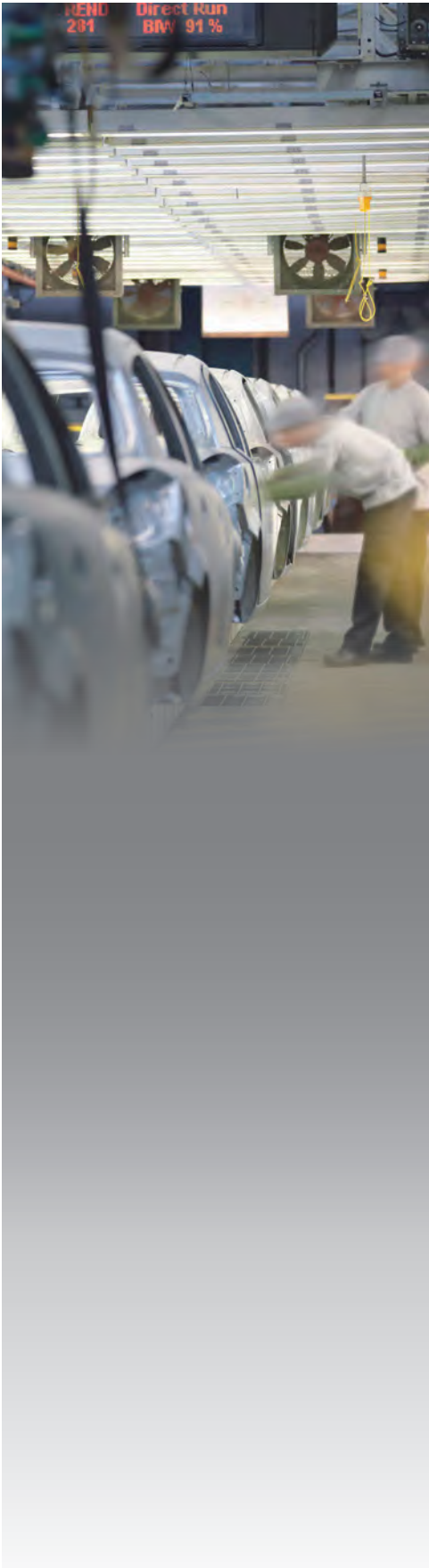

**Application:** Automobile Industry

**Non-linear Loads:** Thyristor driven heater

**Compensation Result:** Voltage harmonic distortion (THDu) was reduced from 5.5% to 1.3%.

Voltage waveform and spectrum are recorded by Fluke 435, as below.

### Voltage Waveform

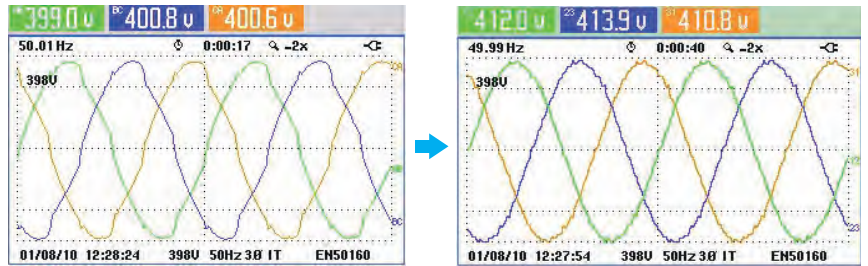

BEFORE

AFTER

### Voltage Spectrum

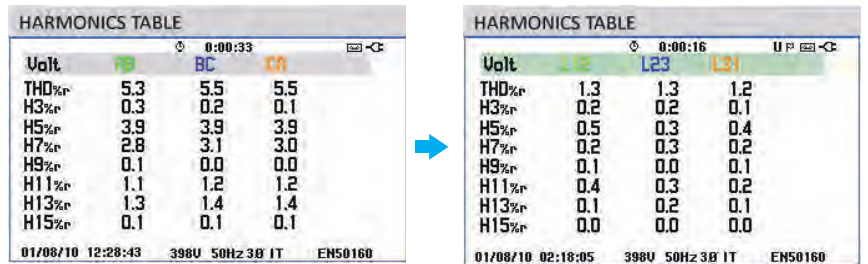

BEFORE

AFTER

# Delta PQC Series APF System Selection

## PQC Series APF Naming Rule

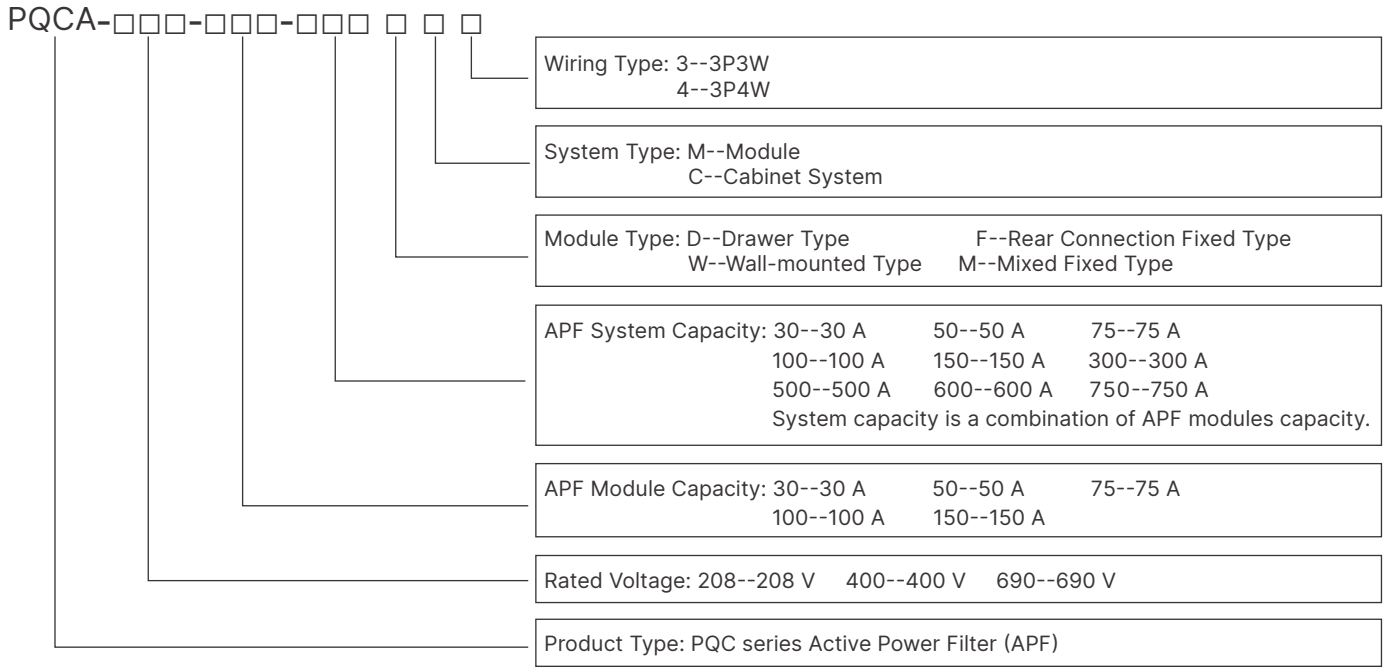

## Delta PQC Series APF Features

- Multifunctional: Harmonic, reactive power and imbalance compensation
- Harmonic Elimination Range: 2<sup>nd</sup>~50<sup>th</sup> order (Selectable)
- High harmonic filtering rate: Up to 98%
- Excellent reactive compensation: High speed, Precise ( $-0.99 \leq PF \leq 0.99$ ), Step-less, Bi-directional (capacitive and inductance) compensation
- Excellent imbalance correction: Both negative and zero sequence, mitigates neutral current
- Wide input voltage & frequency range, adapts to tough electrical environments
- Low thermal loss ( $\leq 3\%$  of rated APF kVA), efficiency  $\geq 97\%$
- High stability: Infinite impedance to grid, avoids harmonic resonance problems
- Flexible application: Modular design, embedded in standard or customized cabinet
- Easy installation and maintenance: Plug-in installation for APF module replacement and expansion
- Wide capacity range: 30~750 A for a single cabinet, up 10 cabinets in parallel
- Environmental adaptability:  $-10\sim 55^{\circ}\text{C}$  ambient temperature, compatible with diesel generator
- Complete protection: Grid Over/Under voltage, APF over current, over temperature, and more. All faults are recorded in the event log, which is convenient for failure analysis
- Waveform display function on HMI: Display waveform of input Voltage, Grid current, Load current and APF current
- Display Harmonic current Histogram on HMI: Grid harmonic current and load harmonic current
- CTs' reversal auto correction can be setted on HMI, support grid side or load side current detection

## PQC Series APF Model

APF System Type	Structure	Model Name	Rated Voltage	APF Capacity	Dimension (W×D×H)	Weight	
Independent Module System	Wall-mounted (Power module and accessories assembled together)	PQCA-208-50-50WC3(4)	208 V	50 A	484×256×887 mm	42.5 kg	
		PQCA-208-75-75WC3(4)	208 V	75 A	484×256×887 mm	43.5 kg	
		PQCA-208-100-100WC3(4)	208 V	100 A	484×256×977 mm	55.5 kg	
		PQCA-208-150-150WC3(4)	208 V	150 A	484×256×977 mm	56.5 kg	
		PQCA-400-30-30WC3(4)	400 V	30 A	484×256×887 mm	41.5 kg	
		PQCA-400-50-50WC3(4)	400 V	50 A	484×256×887 mm	42.5 kg	
		PQCA-400-75-75WC3(4)	400 V	75 A	484×256×887 mm	43.5 kg	
		PQCA-400-100-100WC3(4)	400 V	100 A	484×256×977 mm	55.5 kg	
	Drawer Type Modular	PQCA-400-150-150WC3(4)	400 V	150 A	484×256×977 mm	56.5 kg	
		PQCA-208-50-50DM3(4)	208 V	50 A	484×681×190 mm	35 kg	
		PQCA-208-75-75DM3(4)	208 V	75 A	484×681×190 mm	36 kg	
		PQCA-208-100-100DM3(4)	208 V	100 A	484×771×190 mm	48 kg	
		PQCA-208-150-150DM3(4)	208 V	150 A	484×771×190 mm	49 kg	
		PQCA-400-30-30DM3(4)	400 V	30 A	484×681×190 mm	34 kg	
		PQCA-400-50-50DM3(4)	400 V	50 A	484×681×190 mm	35 kg	
		PQCA-400-75-75DM3(4)	400 V	75 A	484×681×190 mm	36 kg	
	Mixed Fixed Type Modular	PQCA-400-100-100DM3(4)	400 V	100 A	484×771×190 mm	48 kg	
		PQCA-400-150-150DM3(4)	400 V	150 A	484×771×190 mm	49 kg	
		PQCA-208-50-50MM3(4)	208 V	50 A	484×641.5×190 mm	34 kg	
		PQCA-208-75-75MM3(4)	208 V	75 A	484×641.5×190 mm	35 kg	
		PQCA-208-100-100MM3(4)	208 V	100 A	484×731.5×190 mm	47 kg	
		PQCA-208-150-150MM3(4)	208 V	150 A	484×731.5×190 mm	48 kg	
		PQCA-400-30-30MM3(4)	400 V	30 A	484×641.5×190 mm	33 kg	
		PQCA-400-50-50MM3(4)	400 V	50 A	484×641.5×190 mm	34 kg	
	Fixed Type Modular	PQCA-400-75-75MM3(4)	400 V	75 A	484×641.5×190 mm	35 kg	
		PQCA-400-100-100MM3(4)	400 V	100 A	484×731.5×190 mm	47 kg	
			PQCA-400-150-150MM3(4)	400 V	150 A	484×731.5×190 mm	48 kg
	Cabinet System (Multiple Modules)	Drawer Type Cabinet	PQCA-690-100-100FM3	690 V	100 A	605×761×270 mm	78kg
PQCA-208-50/75-125DC3(4)			208 V	125 A	800×1000×2000 mm	305 kg	
PQCA-208-150-150DC3(4)			208 V	150 A	800×1000×2000 mm	295 kg	
PQCA-208-100-200DC3(4)			208 V	200 A	800×1000×2000 mm	325 kg	
PQCA-208-150-300DC3(4)			208 V	300 A	800×1000×2000 mm	325 kg	
PQCA-208-100-400DC3(4)			208 V	400 A	800×1000×2000 mm	435 kg	
PQCA-208-150-450DC3(4)			208 V	450 A	800×1000×2000 mm	380 kg	
PQCA-208-150-600DC3(4)			208 V	600 A	800×1000×2000 mm	435 kg	
PQCA-208-150-750DC3(4)			208 V	750 A	800×1000×2000 mm	490 kg	
PQCA-400-100-100DC3(4)			400 V	100 A	800×1000×2000 mm	295 kg	
PQCA-400-50/75-125DC3(4)			400 V	125 A	800×1000×2000 mm	305 kg	
PQCA-400-150-150DC3(4)			400 V	150 A	800×1000×2000 mm	295 kg	
PQCA-400-100-200DC3(4)			400 V	200 A	800×1000×2000 mm	325 kg	
PQCA-400-100/150-250DC3(4)			400 V	250 A	800×1000×2000 mm	325 kg	
PQCA-400-150-300DC3(4)			400 V	300 A	800×1000×2000 mm	325 kg	
PQCA-400-100/150-350DC3(4)			400 V	350 A	800×1000×2000 mm	380 kg	
PQCA-400-100-400DC3(4)			400 V	400 A	800×1000×2000 mm	435 kg	
PQCA-400-150-450DC3(4)			400 V	450 A	800×1000×2000 mm	380 kg	
PQCA-400-100-500DC3(4)			400 V	500 A	800×1000×2000 mm	490 kg	
PQCA-400-100/150-550DC3(4)			400 V	550 A	800×1000×2000 mm	435 kg	
PQCA-400-150-600DC3(4)			400 V	600 A	800×1000×2000 mm	435 kg	
PQCA-400-100/150-650DC3(4)			400 V	650 A	800×1000×2000 mm	490 kg	
PQCA-400-100/150-700DC3(4)			400 V	700 A	800×1000×2000 mm	490 kg	
PQCA-400-150-750DC3(4)			400 V	750 A	800×1000×2000 mm	490 kg	
Mixed Fixed Type Cabinet			PQCA-208-50/75-125MC3(4)	208 V	125 A	800×1000×2000 mm	305 kg
			PQCA-208-150-150MC3(4)	208 V	150 A	800×1000×2000 mm	295 kg
			PQCA-208-100-200MC3(4)	208 V	200 A	800×1000×2000 mm	325 kg
			PQCA-208-150-300MC3(4)	208 V	300 A	800×1000×2000 mm	325 kg
			PQCA-208-100-400MC3(4)	208 V	400 A	800×1000×2000 mm	435 kg
			PQCA-208-150-450MC3(4)	208 V	450 A	800×1000×2000 mm	380 kg
		PQCA-208-150-600MC3(4)	208 V	600 A	800×1000×2000 mm	435 kg	
		PQCA-208-150-750MC3(4)	208 V	750 A	800×1000×2000 mm	490 kg	
		PQCA-400-100-100MC3(4)	400 V	100 A	800×1000×2000 mm	295 kg	
		PQCA-400-50/75-125MC3(4)	400 V	125 A	800×1000×2000 mm	325 kg	
		PQCA-400-75-150MC3(4)	400 V	150 A	800×1000×2000 mm	325 kg	
		PQCA-400-150-150MC3(4)	400 V	150 A	800×1000×2000 mm	295 kg	
		PQCA-400-100-200MC3(4)	400 V	200 A	800×1000×2000 mm	325 kg	
		PQCA-400-100/150-250MC3(4)	400 V	250 A	800×1000×2000 mm	325 kg	
		PQCA-400-150-300MC3(4)	400 V	300 A	800×1000×2000 mm	325 kg	
		PQCA-400-100/150-350MC3(4)	400 V	350 A	800×1000×2000 mm	380 kg	
		PQCA-400-100-400MC3(4)	400 V	400 A	800×1000×2000 mm	435 kg	
		PQCA-400-150-450MC3(4)	400 V	450 A	800×1000×2000 mm	380 kg	
		PQCA-400-100-500MC3(4)	400 V	500 A	800×1000×2000 mm	490 kg	
		Fixed Type Cabinet	PQCA-400-100/150-550MC3(4)	400 V	550 A	800×1000×2000 mm	435 kg
PQCA-400-150-600MC3(4)			400 V	600 A	800×1000×2000 mm	435 kg	
PQCA-400-100/150-650MC3(4)			400 V	650 A	800×1000×2000 mm	490 kg	
			PQCA-400-100/150-700MC3(4)	400 V	700 A	800×1000×2000 mm	490 kg
			PQCA-400-150-750MC3(4)	400 V	750 A	800×1000×2000 mm	490 kg
			PQCA-690-100-300FC3	690 V	300 A	800×1000×2000 mm	460 kg
			PQCA-690-100-400FC3	690 V	400 A	800×1000×2000 mm	540 kg
		PQCA-690-100-500FC3	690 V	500 A	800×1000×2000 mm	620 kg	

## Delta PQC Series APF Technical Specification

	Rated Voltage	AC 208 V				AC 400 V				AC 690 V		
	Input Voltage Range	AC 166~250 V		AC 166~250 V		AC 228~456 V		AC 228~480 V		AC 384~880 V		
Electrical Specification	Electric Connection	3P4W		3P3W		3P4W		3P3W		3P3W		
	Rated Current per Module	50 A	75 A	100 A	150 A	30 A	50 A	75 A	100 A	150 A		
	Rated Current per Cabinet	50~750 A (Module combination)				30~750 A (Module combination)				100~500 A (Module combination)		
	Rated Frequency	50(60) Hz $\pm$ 10%										
	Input Voltage THD Range	$\leq$ 15%										
	Redundancy	Each module is an independent filtering system										
	Harmonic Elimination Range	2 <sup>nd</sup> ~50 <sup>th</sup> order (Selectable)										
	Harmonic Filtering Degree	0~100% programmable per harmonic in Ampere value										
	Harmonic Filtering Performance	Filter up to 98% harmonics at rated load, THDv < 3%, THDi < 5% after filtering (Precondition: The grid background THDv shall be less than 1% under no-load condition.)										
	Reactive Power Compensation Capability	Both inductive and capacitive reactive power										
	Reactive Power Compensation Performance	Cos $\phi$ $\geq$ 0.99 after compensation (If the APF capacity is sufficient)										
	Imbalance Correction Capability	Mitigate negative and zero sequence										
	Full Response Time	< 10 ms										
	Instant Response Time	< 100 $\mu$ s										
	Thermal Loss	$\leq$ 3% of APF rated capacity										
	Output Current Limitation	Automatic (100% rated capacity)										
	Parallel Expansion (System)	Up to 10 Racks (7 modules per cabinet)										
	MTBF	> 100,000 hours										
	Control Technology	Control Frequency	30 kHz									
		Controller	DSP + FPGA									
CT Position		Grid side or Load side										
Waveform Display		Input Voltage waveform, Grid current waveform, Load current waveform and APF current waveform										
Harmonic Current Histogram Display		Grid harmonic current and load harmonic current										
Communication		Modbus RTU (RS-485), Modbus TCP/IP (Ethernet)										
Physical Specification	IP Grade of Cabinet	IP20, IP30, IP54, IP55 or customization										
	Cooling Method	Intelligent forced air cooling										
	Noise Level	< 65 dB(A) @ 1 m (Module)								< 70 dB(A) @ 1 m (Module)		
	Dust Filter	Optional										
	Dimension	Refer to APF model table										
	Weight	Refer to APF model table										
Environmental Requirement	Ambient Temperature	-10~55°C										
	Relative Humidity	0~95% (No condensation)										
	Altitude	$\leq$ 1000 m (Rated capacity), 1000~3000 m (De-rating 1% per 100 m)										

# Delta PQC series Static Var Generator (SVG)

## SVG Principle

The principle of the SVG is very similar to that of Active Power Filter, as demonstrated in the picture below. When the load is generating inductive or capacitive current, it makes load current lagging or leading the voltage. SVG detects the phase angle difference and generates leading or lagging current into the grid, making the phase angle of current almost the same as that of voltage on the transformer side, which means fundamental power factor is unit.

Delta's PQC series SVG is also capable of correcting load imbalance and compensating part of harmonic currents.

Note: CT is a critical part of the SVG system, and it can be purchased by users themselves, following Delta's suggestions on CT specification.

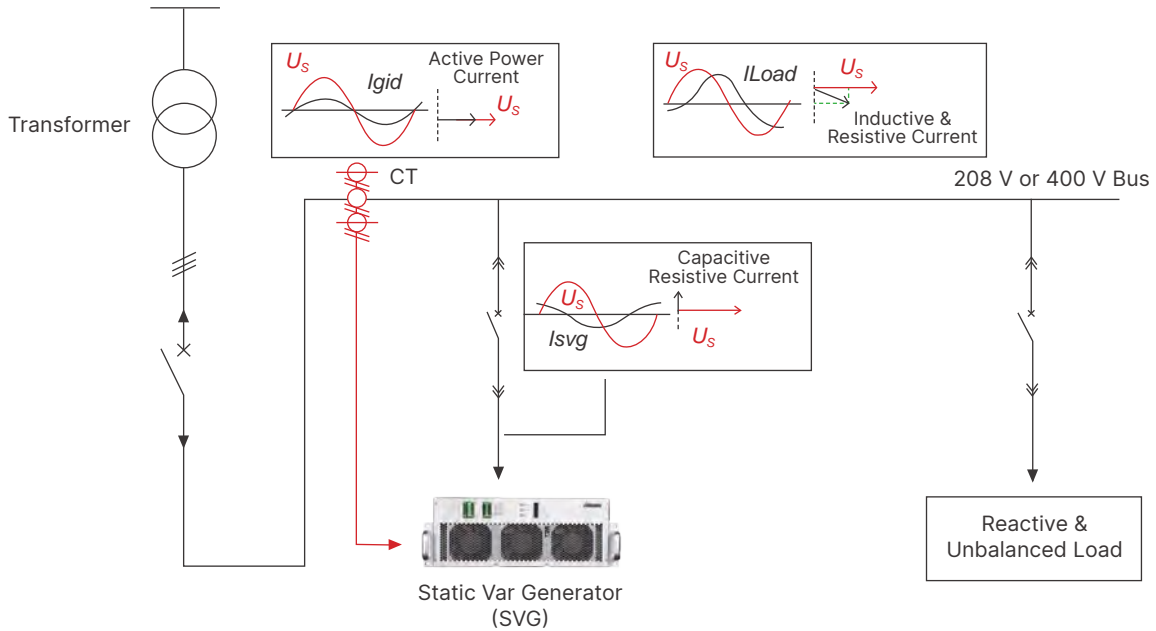

SVG Operating Mode	Waveform and Vector	Remark
No Load Mode	<p>SVG Outputs on Current</p> <p>(a) <math>U_i = U_s</math></p>	$U_i = U_s$ , $I_{svg} = 0$ , SVG outputs no reactive current.
Capacitive Mode	<p>Leading Current</p> <p>(b) <math>U_i &gt; U_s</math></p>	$U_i > U_s$ , $I_{svg}$ is leading the voltage, and its amplitude is continuously adjustable.
Inductive Mode	<p>Lagging Current</p> <p>(c) <math>U_i &lt; U_s</math></p>	$U_i < U_s$ , $I_{svg}$ is lagging the voltage, and its amplitude is continuously adjustable.

## SVG Structure

Delta PQC Series SVG has a modular design, which adopted 3-level inverter topology with 3pcs modular IGBT and DC capacitor components, and the Delta SVG system consists of one or several SVG modules and a HMI display.

SVG's HMI can be shared with Delta APF modules. Each SVG module is an independent reactive power compensation system, and users can change the SVG rating by adding or removing SVG modules.

## SVG Module and Cabinet Solutions

According to cable terminal type, a modular SVG can be divided into two types:

- Drawer type modular SVG (adding pluggable accessories on power cable terminals)
- Mixed fixed type modular SVG (Power cables are fixed from rear side, Signal cables are fixed from front side.)

HMI has two types:

- 7" HMI
- 10" HMI

SVG modules and HMI panel can be embedded in Delta's standard SVG cabinet or a customized cabinet. There are breakers, cable terminals and Surge Protection Device (SPD) in the SVG cabinet. Delta can supply IP30, IP42, IP54 or customized solutions.



SVG cabinet



Mixed fixed SVG module



Drawer type SVG module

## Wall-mounted SVG

Delta's Wall-mounted SVG can be installed on a wall, which is suitable for low rating applications, and wall-mounted type HMI can be installed on the wall-mounted SVG module, along with a mounting bracket to provide support and protection. Delta can supply IP30, IP42, IP54 or customized solutions.



Combined wall-mounted IP30 SVG system



Integral wall-mounted IP30 SVG system



Wall-mounted IP54 SVG system

## SVG Compensation Performance

Delta's PQC Series SVG can rapidly and continuously compensate both inductive and capacitive reactive power correct load imbalance and compensate part of harmonic currents. With sufficient capacity, the SVG ensures excellent fundamental power factor improvement performance.

- Fundamental Power Factor (Cosφ) ≥ 0.99 (improves both leading and lagging PF)



# Delta's PQC Series SVG Actual Compensation Performance



**Application:** Harbor

**Loads:** Inductive Motors.

**Compensation Results:** Fundamental Power Factor ( $\text{Cos}\phi$ ) was improved from 0.82 to 0.99, current RMS value was reduced from 1335 A to 1116 A (around 16%).

Power and Energy were recorded by Fluke 435, as below.

## Power and Energy

Power & Energy				
FUND				
kW	254.8	253.6	256.3	764.8
kVA	307.8	310.9	313.4	932.1
kVAr	172.7	179.8	180.3	532.8
PF	0.81	0.80	0.80	0.81
Cos $\phi$	0.83	0.82	0.82	
A rms	1335	1349	1362	
U rms	233.23	233.06	232.90	

BEFORE

Power & Energy				
FUND				
kW	258.2	260.3	263.2	781.7
kVA	261.3	264.1	266.7	792.1
kVAr	40.2	44.7	43.2	128.1
PF	0.97	0.97	0.97	0.97
Cos $\phi$	0.99	0.99	0.99	
A rms	1116	1128	1142	
U rms	236.72	236.68	236.49	

AFTER



**Application:** Petrochemical Industry

**Loads:** Inductive Motors

**Compensation Result:** Fundamental Power Factor ( $\text{Cos}\phi$ ) was improved from 0.44 to 0.98, current RMS value was reduced from 2436 A to 1289 A (around 47%).

Power and Energy were recorded by Fluke 435, as below.

## Power and Energy

Power & Energy				
FUND				
kW	248.6	241.7	253.9	744.2
kVA	533.2	544.9	548.9	1627
kVAr	471.8	488.3	486.7	1447
PF	0.47	0.45	0.47	0.46
Cos $\phi$	0.47	0.44	0.46	
A rms	2385	2418	2436	
U rms	223.80	225.55	225.48	

BEFORE

Power & Energy				
FUND				
kW	273.2	276.2	282.8	832.3
kVA	281.5	283.1	290.4	854.9
kVAr	67.6	61.8	65.9	195.3
PF	0.97	0.97	0.97	0.97
Cos $\phi$	0.97	0.98	0.97	
A rms	1251	1267	1289	
U rms	225.33	223.80	225.62	

AFTER

# Delta PQC Series SVG System Selection

## PQC Series SVG Naming Rule

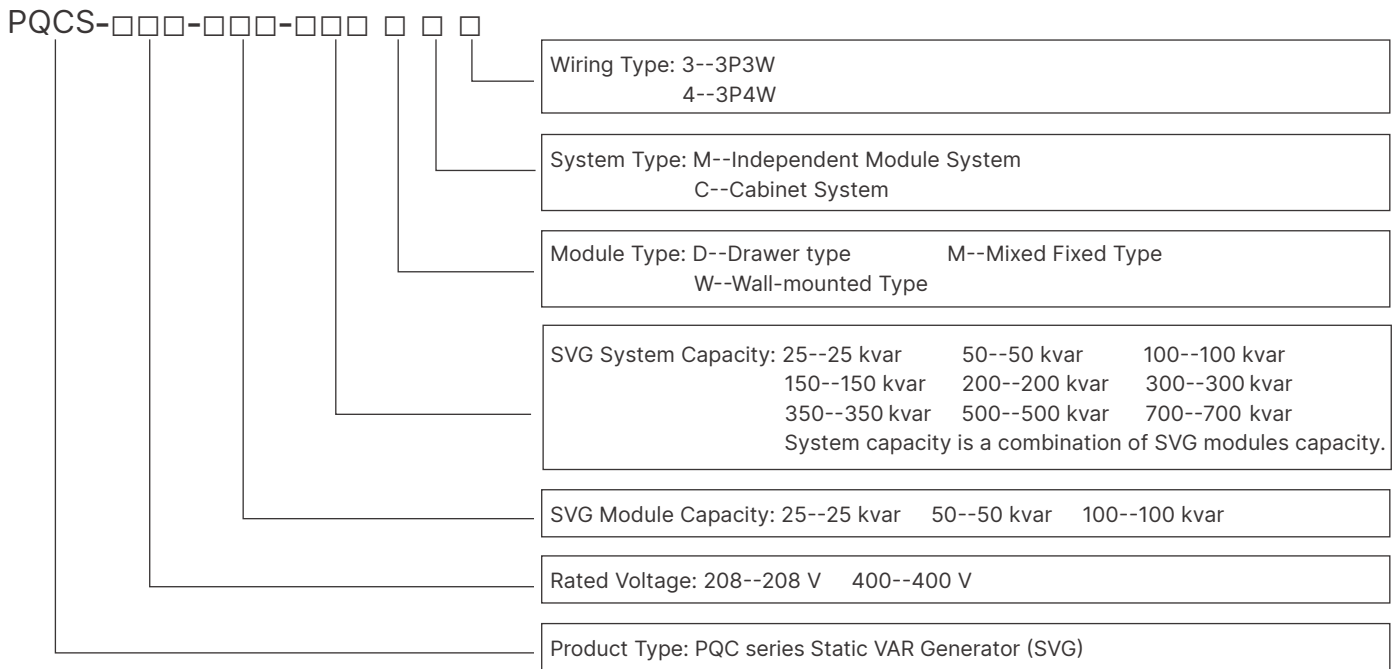

## Delta PQC Series SVG Features

- Multifunctional: Reactive power, imbalance and part of Harmonic compensation
- Excellent reactive compensation: High speed, Precise ( $-0.99 \leq \text{Cos}\phi \leq 0.99$ ), Step-less, Bi-directional (capacitive and inductance) compensation
- Excellent imbalance correction: Both negative and zero sequence, mitigates neutral current
- Harmonic Elimination Range: 2<sup>nd</sup>~25<sup>th</sup> order (Selectable)
- Harmonic current capacity: 20% of rated current, 100 kvar SVG can output 30A H2-H25 harmonic compensation current
- Wide input voltage & frequency range, adapts to tough electrical environment
- Low thermal loss ( $\leq 3\%$  of rated SVG capacity), efficiency  $\geq 97\%$
- High stability: Infinite impedance to grid, avoids harmonic resonance problem
- Flexible application: Modular design, embedded in standard or customized cabinet
- Easy installation and maintenance: Easy installation for SVG module replacement and expansion
- Wide capacity range: 25~700 kvar for a single cabinet, up to 10 cabinets in parallel
- Environmental adaptability: -10~55°C temperature, compatible with diesel generators
- Complete protection: Grid over/under voltage, SVG over current, over temperature, and others. All faults recorded in event log, convenient for failure analysis
- Waveform display function on HMI: Display waveform of input Voltage, Grid current, Load current and SVG current
- Display Harmonic current Histogram on HMI: Grid harmonic current and load harmonic current
- CTs' reversal auto correction can be setted on HMI, support grid side or load side current detection

## PQC Series SVG Model

SVG System Type	Structure	Model Name	Rated Voltage	SVG Capacity	Dimension (W×D×H)	Weight
Independent Module System	Wall-mounted (Power module and accessories assembled together)	PQCS-208-25-25WC3(4)	208 V	25 kVar	484×256×887 mm	42.5 kg
		PQCS-208-50-50WC3(4)	208 V	50 kVar	484×256×977 mm	55.5 kg
		PQCS-400-50-50WC4	400 V	50 kVar	484×256×887 mm	42.5 kg
		PQCS-400-100-100WC3(4)	400 V	100 kVar	484×256×977 mm	55.5 kg
	Drawer Type Modular	PQCS-208-25-25DM3(4)	208 V	25 kVar	484×681×190 mm	35 kg
		PQCS-208-50-50DM3(4)	208 V	50 kVar	484×771×190 mm	48 kg
		PQCS-400-50-50DM3(4)	400 V	50 kVar	484×681×190 mm	35 kg
		PQCS-400-100-100DM3(4)	400 V	100 kVar	484×771×190 mm	48 kg
	Mixed Fixed Type Modular	PQCS-208-25-25MM3(4)	208 V	25 kVar	484×641.5×190 mm	34 kg
		PQCS-208-50-50MM3(4)	208 V	50 kVar	484×731.5×190 mm	47 kg
		PQCS-400-50-50MM3(4)	400 V	50 kVar	484×641.5×190 mm	34 kg
		PQCS-400-100-100MM3(4)	400 V	100 kVar	484×731.5×190 mm	47 kg
Cabinet System (Multiple Modules)	Drawer Type Cabinet	PQCS-208-25/50-75DC3(4)	208 V	75 kVar	800×1000×2000 mm	295 kg
		PQCS-208-50-100DC3(4)	208 V	100 kVar	800×1000×2000 mm	325 kg
		PQCS-208-50-200DC3(4)	208 V	200 kVar	800×1000×2000 mm	380 kg
		PQCS-208-50-300DC3(4)	208 V	300 kVar	800×1000×2000 mm	380 kg
		PQCS-208-50-350DC3(4)	208 V	350 kVar	800×1000×2000 mm	610 kg
		PQCS-400-100-100DC3(4)	400 V	100 kVar	800×1000×2000 mm	295 kg
		PQCS-400-100-200DC3(4)	400 V	200 kVar	800×1000×2000 mm	325 kg
		PQCS-400-100-300DC3(4)	400 V	300 kVar	800×1000×2000 mm	380 kg
		PQCS-400-100-400DC3(4)	400 V	400 kVar	800×1000×2000 mm	435 kg
		PQCS-400-100-500DC3(4)	400 V	500 kVar	800×1000×2000 mm	490 kg
		PQCS-400-100-600DC3(4)	400 V	600 kVar	800×1000×2000 mm	550 kg
		PQCS-400-100-700DC3(4)	400 V	700 kVar	800×1000×2000 mm	610 kg
	Mixed Fixed Type Cabinet	PQCS-208-25/50-75MC3(4)	208 V	75 kVar	800×1000×2000mm	295 kg
		PQCS-208-50-100MC3(4)	208 V	100 kVar	800×1000×2000 mm	325 kg
		PQCS-208-50-200MC3(4)	208 V	200 kVar	800×1000×2000 mm	380 kg
		PQCS-208-50-300MC3(4)	208 V	300 kVar	800×1000×2000 mm	380 kg
		PQCS-208-50-350MC3(4)	208 V	350 kVar	800×1000×2000 mm	590 kg
		PQCS-400-100-100MC3(4)	400 V	100 kVar	800×1000×2000 mm	295 kg
		PQCS-400-50/100-150MC3(4)	400 V	150 kVar	800×1000×2000 mm	325 kg
		PQCS-400-100-200MC3(4)	400 V	200 kVar	800×1000×2000 mm	325 kg
		PQCS-400-50/100-250MC3(4)	400 V	250 kVar	800×1000×2000 mm	380 kg
		PQCS-400-100-300MC3(4)	400 V	300 kVar	800×1000×2000 mm	380 kg
		PQCS-400-50/100-350MC3(4)	400 V	350 kVar	800×1000×2000 mm	435 kg
		PQCS-400-100-400MC3(4)	400 V	400 kVar	800×1000×2000 mm	435 kg
		PQCS-400-50/100-450MC3(4)	400 V	450 kVar	800×1000×2000 mm	490 kg
		PQCS-400-100-500MC3(4)	400 V	500 kVar	800×1000×2000 mm	490 kg
		PQCS-400-50/100-550MC3(4)	400 V	550 kVar	800×1000×2000 mm	540 kg
		PQCS-400-100-600MC3(4)	400 V	600 kVar	800×1000×2000 mm	540 kg
		PQCS-400-50/100-650MC3(4)	400 V	650 kVar	800×1000×2000 mm	590 kg
		PQCS-400-100-700MC3(4)	400 V	700 kVar	800×1000×2000 mm	590 kg

## Delta PQC Series SVG Technical Specification

	Rated Voltage	AC 208 V		AC 400 V	
	Electrical Specification	Input Voltage Range	AC 166~250 V	AC 166~250 V	AC 228~456 V
	Electric Connection	3P4W	3P3W	3P4W	3P3W
	Rated Capacity per Module	25 kvar / 50 kvar		50 kvar / 100 kvar	
	Rated Current per Cabinet	25~350 kvar (Module combination)		50~700 kvar (Module combination)	
	Rated Frequency	50(60) Hz $\pm$ 10%			
	Input Voltage THD Range	$\leq$ 15%			
	Redundancy	Each module is an independent reactive compensation system			
	Reactive Power Compensation Capability	Both inductive and capacitive reactive power			
	Reactive Power Compensation Performance	$\text{Cos}\phi \geq 0.99$ after compensation (If the SVG capacity is sufficient)			
	Imbalance Correction Capability	Mitigate negative and zero sequence			
	Harmonic Elimination Range	2 <sup>nd</sup> ~25 <sup>th</sup> order (Selectable)			
	Harmonic Current Capacity	20% of rated current			
	Full Response Time	< 10 ms			
	Instant Response Time	< 100 us			
	Thermal Loss	$\leq$ 3% of SVG rated capacity			
	Output Current Limitation	Automatic (100% rated capacity)			
	Parallel Expansion (System)	Up to 10 Racks (7 modules per cabinet)			
	MTBF	> 100,000 hours			
Control Technology	Control Frequency	30 kHz			
	Controller	DSP + FPGA			
	CT Position	Grid side or Load side			
	Waveform Display	Input Voltage waveform, Grid current waveform, Load current waveform and SVG current waveform			
	Harmonic Current Histogram Display	Grid harmonic current and load harmonic current			
Physical Specification	Communication	Modbus RTU (RS-485), Modbus TCP/IP (Ethernet)			
	IP Grade of Cabinet	IP20, IP30, IP54, IP55 or customization			
	Cooling Method	Intelligent forced air cooling			
	Noise Level	< 65 dB(A) @ 1 m (Module)			
	Dust Filter	Optional			
	Dimension	Refer to SVG model table			
Environmental Requirement	Weight	Refer to SVG model table			
	Ambient Temperature	-10~55°C			
	Relative Humidity	0~95% (No condensation)			
	Altitude	$\leq$ 1000 m (Rated capacity), 1000~3000 m (Derating 1% per 100 m)			



# Special Features of Delta Power Quality Solution

## High Adaptability

- **Wider range of operating temperatures**

Delta PQC series APF & SVG can normally work from -10~55°C, which is suitable for most applications

- **Withstands extreme electrical condition**

Delta's PQC series APF & SVG can withstand severe harmonic distortion of voltage, they can work normally under conditions with THDu (total harmonic distortion of voltage) up to 15%

- **Compatible with diesel generators**

## Simple and Flexible Application

- The Delta PQC series APF & SVG's modular structure makes it easy for installation, maintenance and capacity expansion.

- APF & SVG modules can be embedded in Delta's standard cabinets or a customized cabinets, making it possible to customize cabinets for special requirements.

## Excellent Compensation Capability

- Delta's PQC series APF & SVG adopts 3-level inverter topology with 3pcs modular IGBT and up to 30 kHz switching frequency, which provide excellent power quality compensation accuracy, response speed and output ability.

## High Reliability

- Module redundancy technology
- Intelligent air cooling technology
- Top brand electronic components
- Advanced production technology



The **PQC series APF** protects electrical equipment for a leading petrochemical company in Taiwan.



The **PQC series APF** protects the power distribution system of one of India's top three textile companies.



The **PQC series APF** boosts the power supply stability for a global automobile parts provider in India.



The **PQC series APF** protects the power distribution system from harmonics interference for the largest telecom company in India.



The **PQC series APF** helps to reduce the electricity bills for an international rubber & tire company in Thailand.

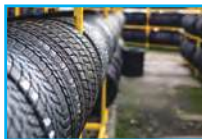

The **PQC series APF** protects the power distribution system for a public sports facility in Australia.



# critical Operations 24/7



The **PQC series APF** protects the power distribution system from harmonics for Asia's largest chemical fiber company in China.



The **PQC series APF** protects the power distribution system for a top petrochemical company in China



The **PQC series APF** boosts power supply stability for public metro system in three different cities of China.



The **PQC series APF** protects the power distribution system from harmonics interference for the largest telecom company in China.



The **PQC series APF** protects the power distribution system for a public water supply company in South Korea.



The **PQC series APF** boosts the power supply stability for an electronic components & battery material company in South Korea.

## Europe

### Czech Republic

Delta Energy Systems  
T +420 272 019 330  
E ups.czech.republic@deltaww.com

### Finland

Delta Solutions (Finland) Oy  
T +358 9 84966 0  
E ups.finland@deltaww.com

### France

Delta Electronics (France) S.A.  
T +33 1 69 77 82 60  
E ups.france@deltaww.com

### Germany

Delta Energy Systems (Germany) GmbH  
T +49 2921 987 0  
E ups.germany@deltaww.com

### The Netherlands - EMEA Headquarters

Delta Electronics (Netherlands) BV  
T +31 (0) 20 800 39 00  
E ups.netherlands@deltaww.com

### Poland

Delta Electronics (Poland) Sp. z.o.o.  
T +48 22 335 26 00  
E ups.poland@deltaww.com

### Russia

Delta Energy Systems LLC  
T +7 495 644 3240  
E ups.russia@deltaww.com

### Slovak Republic

Delta Electronics (Slovakia) s.r.o.  
T +421 2 6541 1258  
E ups.slovakia@deltaww.com

### Switzerland

Delta Electronics (Switzerland) AG  
T +41 31 998 53 11  
E ups.switzerland@deltaww.com

### Spain

Delta Electronics Solutions (Spain) SLU.  
T +34 91223 7420  
E ups.spain@deltaww.com

### Turkey

Delta Greentech Electronic San. Ltd.  
T +90 216 499 9910  
E ups.turkey@deltaww.com

### United Kingdom

Delta Electronics Europe Ltd.  
T +44 1355 588 888  
E ups.united.kingdom@deltaww.com

## Middle-East & Africa

### South Africa

Delta Energy Systems MEA (Switzerland) AG  
T +27 12 663 2714  
E ups.south.africa@deltaww.com

### United Arab Emirates

Delta Energy Systems (Switzerland) AG  
T +971 425 99 55 3  
E info.middle-east@deltaww.com

## Americas

### Brazil

Delta Electronics Brasil Ltda.  
T +55 12 3932 2300  
E ups.brazil@deltaww.com

### The United States

Delta Electronics (Americas) Ltd.  
T +1 510 344 2157  
E ups.na@deltaww.com

## Asia Pacific

### Australia

Delta Energy Systems Australia Pty Ltd.  
T +61 3 9543 3720  
E ups.australia@deltaww.com

### China

Delta GreenTech (China) Co., Ltd.  
T +86 21 5863 5678 / +86 21 5863 9595  
E ups.china@deltaww.com

### India

Delta Power Solutions (India) Pvt. Ltd.  
T +91 124 4874 900  
E ups.india@deltaww.com

### Indonesia

E ups.indonesia@deltaww.com

### South Korea

Delta Electronics (Korea), Inc.  
T +82 2 515 5303  
E ups.south.korea@deltaww.com

### Malaysia

E ups.malaysia@deltaww.com

### Philippines

E ups.philippines@deltaww.com

### Singapore

Delta Energy Systems (Singapore) Pte Ltd.  
T +65 6747 5155  
E ups.singapore@deltaww.com

### Taiwan

Delta Electronics Inc.  
T +886 6 505 6565  
E ups.taiwan@deltaww.com

### Thailand

Delta Electronics (Thailand) Public Co., Ltd.  
T +662 709 2800  
E ups.thailand@deltaww.com

### Vietnam

E ups.vietnam@deltaww.com

